

# MovieTech

GRIP EQUIPMENT YOU CAN RELY ON!



## GIZMO JIB TECHNICAL USER GUIDE

Version: 10/2023

Language: English

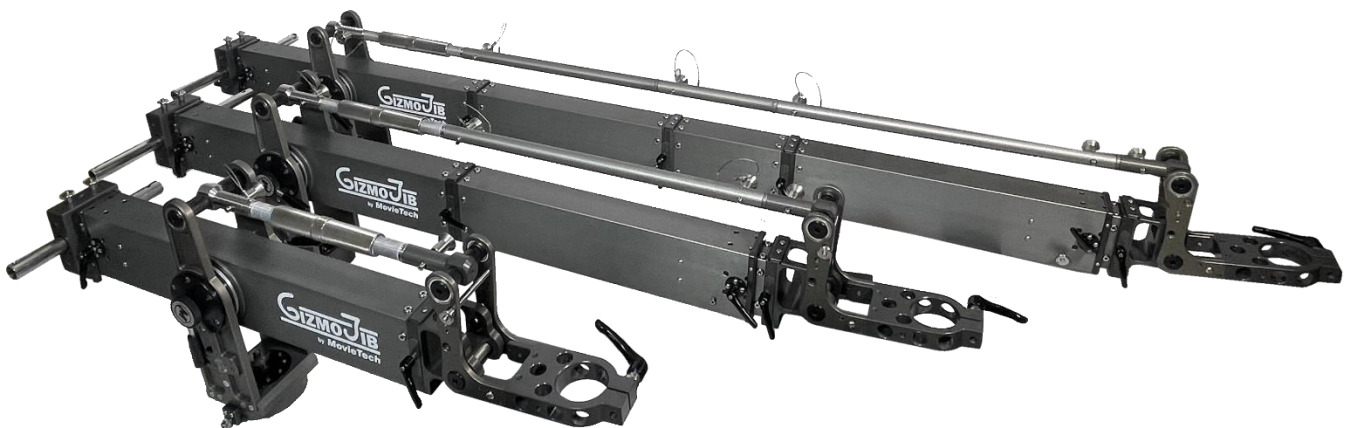

MovieTech AG  
Martin-Kollar-Str. 9  
80801 Munich – Germany  
+49 (0) 89 /436 891 3 | [info@movietech.de](mailto:info@movietech.de)



## Inhaltsverzeichnis

1. Introduction.....	4
2. General Information .....	5
1) Intended use:.....	5
2) Product details.....	5
3) Warranty.....	6
3. EU – Declaration of conformity.....	7
4. Safety Guidelines.....	8
5. How to set it up.....	11
1) Set-Up: step by step .....	11
6. Technical Description.....	16
1) GIZMO Jib – Version S.....	17
2) GIZMO Jib – Version M.....	18
3) GIZMO Jib – Version L.....	19
4) GIZMO Jib – Version XL.....	20
5) GIZMO Jib – Version XXL.....	21
7. Recurrent inspection.....	22

## 1. Introduction

We are very glad that you decided to work with our MovieTech GIZMO JIB.

We hope you enjoy it as much as we do !

Everyone at MovieTech is passionate about grip equipment. In case you have useful feedback for us or you have a question concerning our products, please do not hesitate a second to contact us – we´re gladly there for you!

To make your experience with this Jib most enjoyable, please follow these instructions carefully. Any camera Jib is only as safe as the person operating it.

These are our contact details:

**MovieTech AG**  
Martin-Kollar-Str. 9  
80801 Munich – Germany  
+49 (0) 89 /436 891 3 | info@movietech.de



All the best,  
Your MovieTech Team.



## 2. General Information

### 1) Intended use:

The GIZMO JIB is a mobile camera jib arm which shall only be used to carry cameras remote heads for use in motion picture productions in a stationary position (on levelling legs) or on tracks (with track wheels). The system may not be used for any purpose other than that specified.

The GIZMO Jib System can be set up in various different assembly versions. This user manual describes the most common configurations. Configurations that are not described in this user manual require prior configuration of the MovieTech technical department. Components of other camera jib arms may not be combined with any component of the GIZMO Jib.

Please carefully read and understand the following safety instructions and set up manual before use of the equipment! Operating the jib can be dangerous when the safety instructions as follows are not strictly taken care of. The jib may only be set-up by trained and skilled staff and in accordance to the instructions as follows.

### 2) Product details

<b>Product:</b>	<b>MovieTech GIZMO Jib</b>	
Manufacturer:	MovieTech AG Martin-Kollar-Str. 9 D- 80801 München +49 (0) 89 /436 891 3	
Payload:	Depending on version (see following pages)	
Material:	Aluminum (mainly), stainless steel, synthetic materials	
Surface treatment:	Anodization, HART-COAT®	
Year of construction:		
Version:		
Serial no.:		
Purchaser:	Company:	
	Address:	
	Contact details:	
	Contact person:	

### 3) Warranty

All parts have a warranty period of 12 months, beginning on the date of delivery.

**Caution:** Any warranty expires if operating and maintenance instructions are not strictly followed. The same applies if any changes are made to the product, if parts of the equipment are replaced with external parts, or if the equipment is handled improperly.

The purchaser undertakes to exempt us from any claims for compensation which might arise on the part of third parties vis-à-vis us, whether resulting from putting into service or from using the equipment. The purchaser must inform our customer service management in writing about any discernible defects without delay – at the latest, however, within one week after receipt of the delivered item. Defects which do not become discernible within this period, even after careful examinations, must be reported to MovieTech by the purchaser in writing immediately after discovery. In the event that the purchaser should report that the products do not correspond to the warranty, we may require at our discretion that either

- the defective equipment or the defective part is to be sent to MovieTech for repair and subsequent return, or
- the purchaser keeps the defective equipment or the defective part available, and we shall commission an expert who will be sent to carry out the repair.

Transport cost and travelling expenses incurred for the purpose of remedying defects shall be borne by the purchaser. Defects which occur to the equipment as a result of natural wear and tear are not covered by the warranty. When asserting claims under warranty, it is the duty of the purchaser to prove that the defects were not caused by any circumstance which are among the risks within his sphere of responsibility (such as transport damage, improper operation, etc.). Any further claims in particular claims for damages for direct or indirect damage are excluded. If after an appropriate time it is not possible to remedy the defect, the purchaser may at his discretion demand a reduction of the payment or cancellation of the contract. Only the direct purchaser shall be entitled to make warranty claims against MovieTech; such claims are not assignable.

### 3. EU – Declaration of conformity



– Declaration of Conformity

Company: MovieTech AG  
Martin-Kollar-Str. 9  
DE 81829 München

We hereby certify that the following described machine in its conception, construction and form put by us into circulation is in accordance with all the relevant essential health and safety requirements of the EC machinery directive.

**This declaration is no longer valid if the machine is modified without our consent.**

**Camera Jib Arm**

**Type: GIZMO Jib**

Appropriate regulations: DIN EN ISO 12100  
Richtlinie für Veranstaltungs- und Produktionsstätten für szenische  
Darstellung (VGB 70) entspricht.  
DGUV V17 (formerly BGVC1)  
DIN 15999

A handwritten signature in blue ink, appearing to read 'Sebastian'.

München, 2023/10/24

## 4. Safety Guidelines



- Training for a safe operation of the system is offered by Movie Tech. Contact us +49 (0) 89 436 89 1 3
- Personnel must wear safety shoes, since the counterweights can present a particular danger if they fall.
- Minimum Age to operate the Jib system is 18 years.
- You must read and understand the instruction manual before using the Jib. The instruction manual must always be available to the operator at the point of use.
- The Jib may only be operated when balanced horizontally in all directions. Levelling legs or a level track are used for alignment. A bubble level is used to check the balance. A commercially available bubble level can also be used.
- The jib can only be operated on levelling legs or with guide wheels. The mounted pneumatic tyres are used to transport the jib to the point of use only. The pneumatic tyres can be used to move the erected jib without payload and without the corresponding counterweight.
- The jib may not be operated in a manned platform version
- Make sure that the ground can bear the weight of the Jib before setting it up (at least 1000 kg/m<sup>2</sup>). The surface load is a result of the Jib's own weight in the required version plus counterweight and payload divided by the footprint or contact area. On this basis, the total surface load is approx. 1.5 m<sup>2</sup> (load-bearing capacity of ceilings in buildings). For the load under an individual levelling leg, particularly important in an open area, a third of the total weight of the version used is to be taken into account. It may be necessary to increase the area under the levelling legs using wooden plates or similar (grass, meadow, beach).
- Do not set up or operate the Jib while under the influence of drugs, alcohol or other medicines and narcotics.
- Never operate the Jib in the immediate vicinity of high-voltage lines – danger to life.
- The Jib must be shut down in sufficient time before the maximum permitted operating wind of 25 km/h or 6,9 m/s (15.5mph) is reached.
- Particular care is required when operating the Jib in unfavourable weather conditions. The Jib must be shut down in sufficient time when a thunderstorm is threatening. When in doubt, the Jib should be secured and the area evacuated. Pathways and operating elements should be kept free of ice if there is a risk of ice forming.



## GRIP EQUIPMENT YOU CAN RELY ON!

- All elements of the Jib must be within the field of vision of the operating personnel when in use. Visual obstructions can include window blinds, fog or darkness. The Jib can only be moved by line of sight.
- Any movements to be carried out with the Jib must be adequately rehearsed. Pay particular attention to keeping the area of movement in front of and behind the Jib free of obstacles. Quick movements and/or panning must be rehearsed starting at low speeds. Make sure that the stability of the Jib is not negatively affected by the dynamics of the quicker movement under increasing speed. Pay attention to critical situations that may arise when lifting a levelling leg or guide wheel.
- **EXTREME CAUTION:** These safety measures are especially important when moving the Jib on curved tracks! The maximum speed in the circle (Master Track, diameter approx. 6 m) is 6.5 km/h | 4 mph (slow walking pace), which corresponds to 35°/sec. or three crossties per second. Caution – risk of tipping!
- All materials and equipment used must be securely attached to prevent any drops.
- Prevent the unauthorised use of the erected Jib system.
- It is not allowed to exceed the maximum payload of the respective version and the corresponding maximum counterweight.
- Do not operate the Jib on vehicles of any type – uncontrollable movements can be dangerous. (communication between driver <=> operating personnel, uneven surface, etc.)
- Standing under overhead loads until release by operating personnel is prohibited. Keep the danger zone cordoned off until release and mark as a danger zone if necessary. People within the pivoting range of the Jib must be specially instructed and informed about the dangers. The operator must anticipate that such individuals may suddenly find themselves within pivoting range of the Jib and therefore, must maintain a safe distance to the Jib to ensure sufficient reaction time.
- Should you need to route cable along the Jib arm to the remote head or camera, the cable should not negatively impact the movements of the Jib in any way. It should also be noted that the weight of the cable counts towards the overall payload.
- The Jib system and its individual components should be clean and dry when stored. Any accumulated dirt can negatively impact proper function when the Jib is operated next.
- When transporting the Jib system, make sure that the components do not rub together and cause any material wear. Severe damage to the surface coating can lead to increased corrosion. Also make sure when transporting the individual components that they do not hit against each other to avoid bending or denting them. Any bends or dents can weaken the structure and make the system unusable.
- Jib components that have become unusable must be professionally disposed of. Movie Tech AG can properly dispose of such components for you by sending them back to us.



## GRIP EQUIPMENT YOU CAN RELY ON!

- Warranty: The manufacturer accepts no liability for damages or injuries for incidents or accidents occurring due to negligence by the Jib operator or misuse of the Jib or disregarding the instruction manual.
- To avoid accidents due to misuse, Accident Prevention Guidelines especially DGUV regulation 1 (previously BGV A1), and DGUV regulation 3 (previously BGV A3) as well as VDE regulations (especially VDE 0105 section 100) must be adhered to. If the nominal voltage cannot be determined, a minimum clearance of 2m must be kept at all times.
- The load capacities stated contain all elements that are being attached.
- Mark the Jib's working area (e.g. with flags of safety band) in order to keep all persons away from working area at any time.
- Important note: All equipment mounted to the Jib may only be adjusted or dismantled with the clear consent of the Jib operator, as this may interfere with the balance of the system as a whole. Counterweight must be taken out of the Jib and the outrigger needs to be secured before camera or any weight is taken off of the Jib.
- Never operate with a damaged Jib. Immediately stop operating the Jib system when a damage occurs.
- Only use original MovieTech parts or parts authorized by MovieTech.
- What to do when damages occur or an accident happened:

Please immediately inform MovieTech about how the accident took place, how severe it was and about any kind of damage to the Jib. Damaged parts should be sent back to the MovieTech factory for evaluation, repair and replacement. Operating the Jib with damaged parts is not allowed – MovieTech takes no liability for damages or injuries due to the use of damaged parts. Please follow the locally applicable accident prevention guidelines!

Please be aware of possible dangers at all times and work with caution and responsibility.



**STAY SAFE !!**



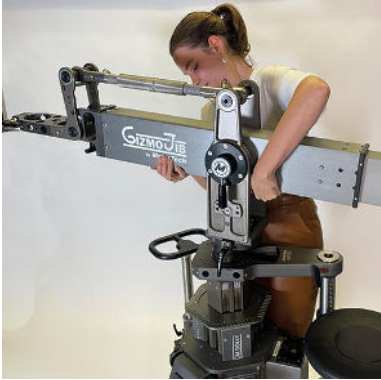

## 5. How to set it up

### 1) Set-Up: step by step

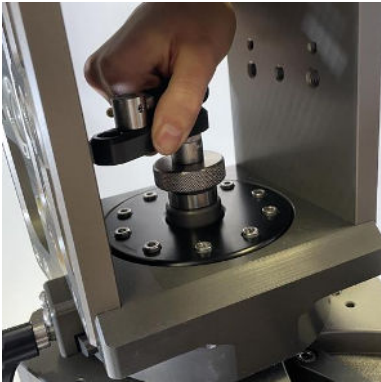
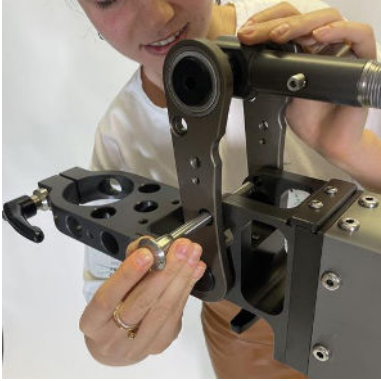
Step	Description	Details
<b>1 . Secure work area</b>	Make sure that there are no unauthorized persons or objects in the working area of the Jib. If necessary, markings with barrier tapes or warning signs are required.	
<b>2. Base or Tripof on firm ground or on tracks</b>	Position the Base Dolly on a firm and stable ground.  On tracks: set up tracks according to the respective set-up manual. Always use appropriate track support. Tracks need to be levelled precisely  On firm ground: If needed, please use ground support	

<p><b>3. Attach main segment</b></p>	<p>Attach the Jib support to the dolly or tripod. Add main segment and close the screw.</p>	  
<p><b>4. Attach Jib Segments</b></p>	<p><b>DEPENDING ON JIB VERSION</b></p> <ul style="list-style-type: none"><li>- Lock jib head to prevent it from falling</li><li>- Take off jib head</li><li>- Best use Jib support</li></ul>	

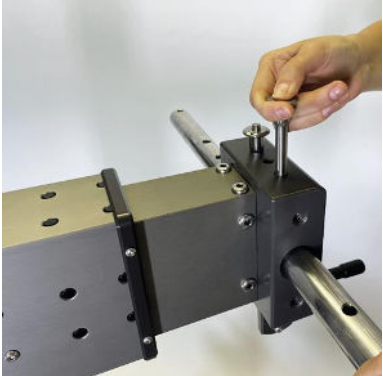
	<ul style="list-style-type: none"><li>- Add Jib segments according to the version you want to set up (see setup version below)</li><li>- Close all levers between every segment</li></ul>	  
<p><b>6. Add parallelogram bars</b></p>	<ul style="list-style-type: none"><li>- select desired length of the telescopic front segment</li><li>- add the parallelogram elements by using the attached quick pin</li><li>- select appropriate length of the telescopic parallelogram bracing rod.</li></ul>	

	<ul style="list-style-type: none"> <li>- Level the jib head</li> </ul>	
<p><b>7. Mount counter weight bars</b></p>	<ul style="list-style-type: none"> <li>- mount the counterweight bars and fixate them with ball lock pin.</li> </ul> <p>Note: there are different counter weight bars depending on the version of Gizmo Jib.</p>	
<p><b>10. Add your camera</b></p>	<ul style="list-style-type: none"> <li>- Add your camera.</li> </ul>	
<p><b>11. Add counterweight</b></p>	<ul style="list-style-type: none"> <li>- insert the counterweight bars</li> <li>- add counterweight</li> </ul>	
<p><b>12.fine adjust the weight</b></p>	<ul style="list-style-type: none"> <li>- fine adjust the Jib with the help of the precise crank rear end and the lever on your Jib parallelogram rods.</li> </ul>	

## Brakes and friction brakes

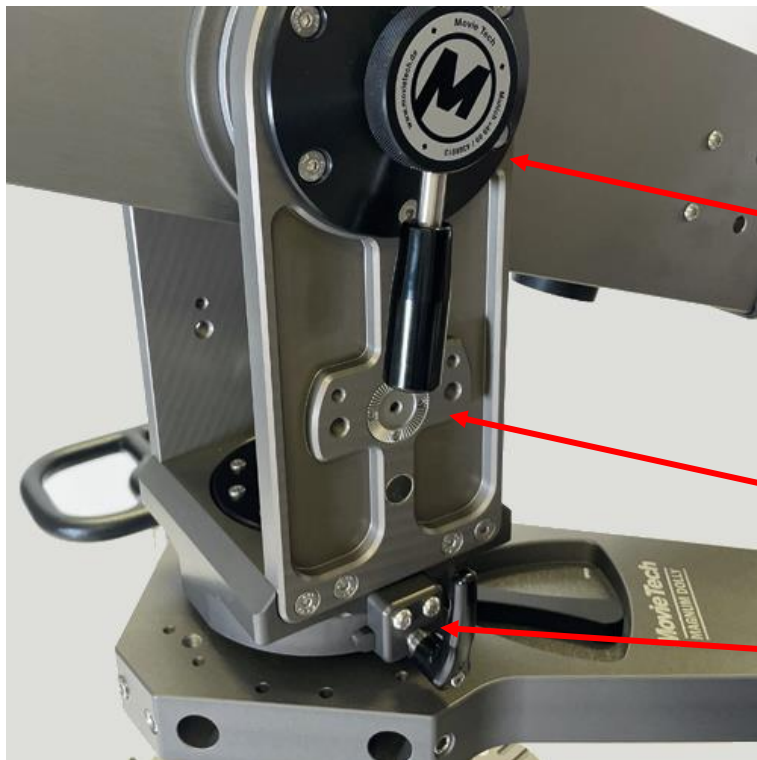

Tilt brake (both sided)

Display-holder mount

Pan friction (both sided)

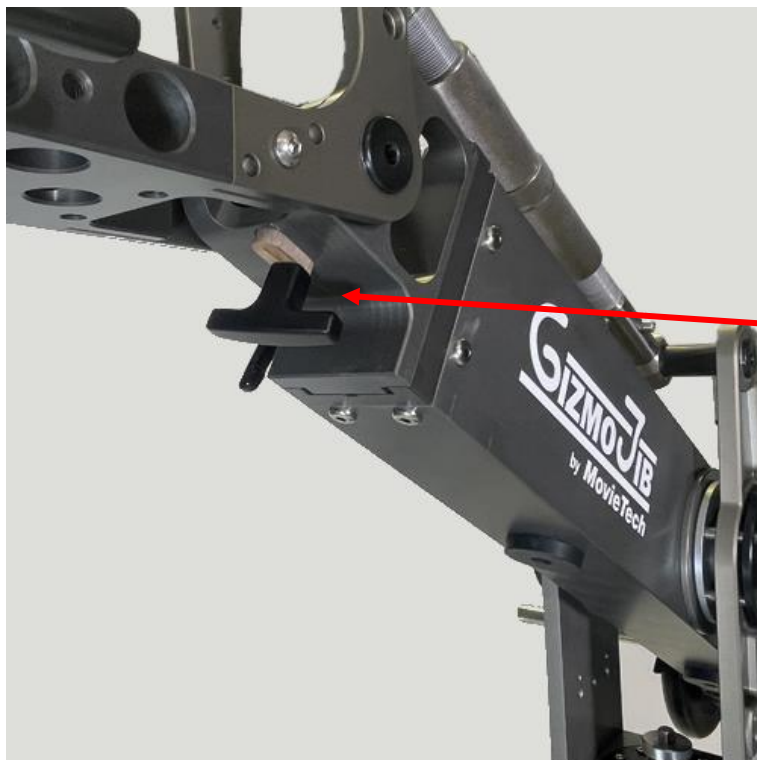

Tilt friction

## 6. Technical Description

**Note:** Any camera Jib is only as safe as the person operating it!  
Follow these instructions carefully to ensure a safe and enjoyable experience with the MovieTech Gizmo Jib.



### ATTENTION

The GIZMO Jib is a lightweight construction made of a special squared tube. Despite its low self-weight, it can hold cameras and remote heads as heavy as 80 kg (176 lbs) in the Versions M and S. **Please note that the maximum load capacity decreases with an increase in Jib length.**

It's recommended to operate all Jib versions on a solid base dolly. Shorter Versions may also be operated in combination with the Bullstand tripod.

	Self-weight	Max. payload		Counterweight	
		Retracted	Extracted	Retracted	Extracted
Version S	23kg(51 lbs)	80kg(176 lbs)	-	52 kg (115 lbs)	-
Version M	30kg(66 lbs)	80kg(176 lbs)	70kg(154 lbs)	120kg (265 lbs)	152kg(335lbs)
Version L	40kg(80 lbs)	60kg(132 lbs)	50kg(110 lbs)	184kg (406 lbs)	188kg(415lbs)
Version XL	44,5kg(98 lbs)	45kg(99 lbs)	40kg(80 lbs)	192kg (423 lbs)	200kg(441lbs)
Version XXL	49kg(108 lbs)	35kg(77 lbs)	30kg(66 lbs)	204kg (450 lbs)	200kg(441lbs)

2x Counterweight bar short	Max. 128 kg
2x Counterweight bar long	Max. 208 kg

TRIPOD – Bullstand (8321-03)	BASE DOLLY – CD 8 (7540-01Set)
	

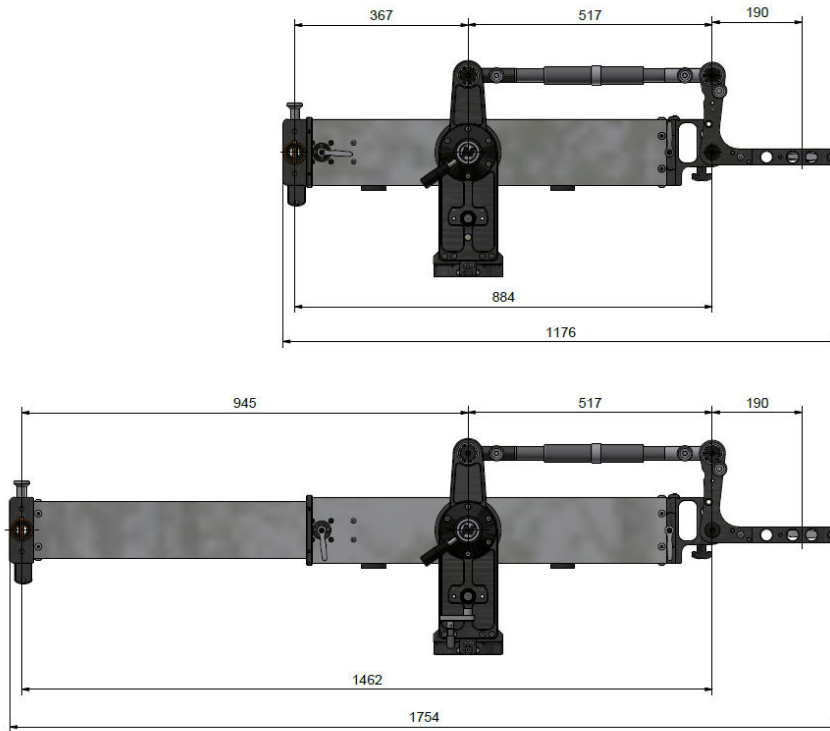

**1) GIZMO Jib – Version S****Package includes:**

- 1 x Main Segment with crankable rear piece
- 1 x Euro-mount head piece
- 2 x Counterweight bars short

**Technical Data**

<b>GIZMO Jib – S</b>	
<b>Weight</b>	23 kg (50,7 lbs)
<b>Max. payload</b>	80 kg (176 lbs)
<b>Counterweight required.</b>	52 kg (115 lbs)

**2) GIZMO Jib – Version M**

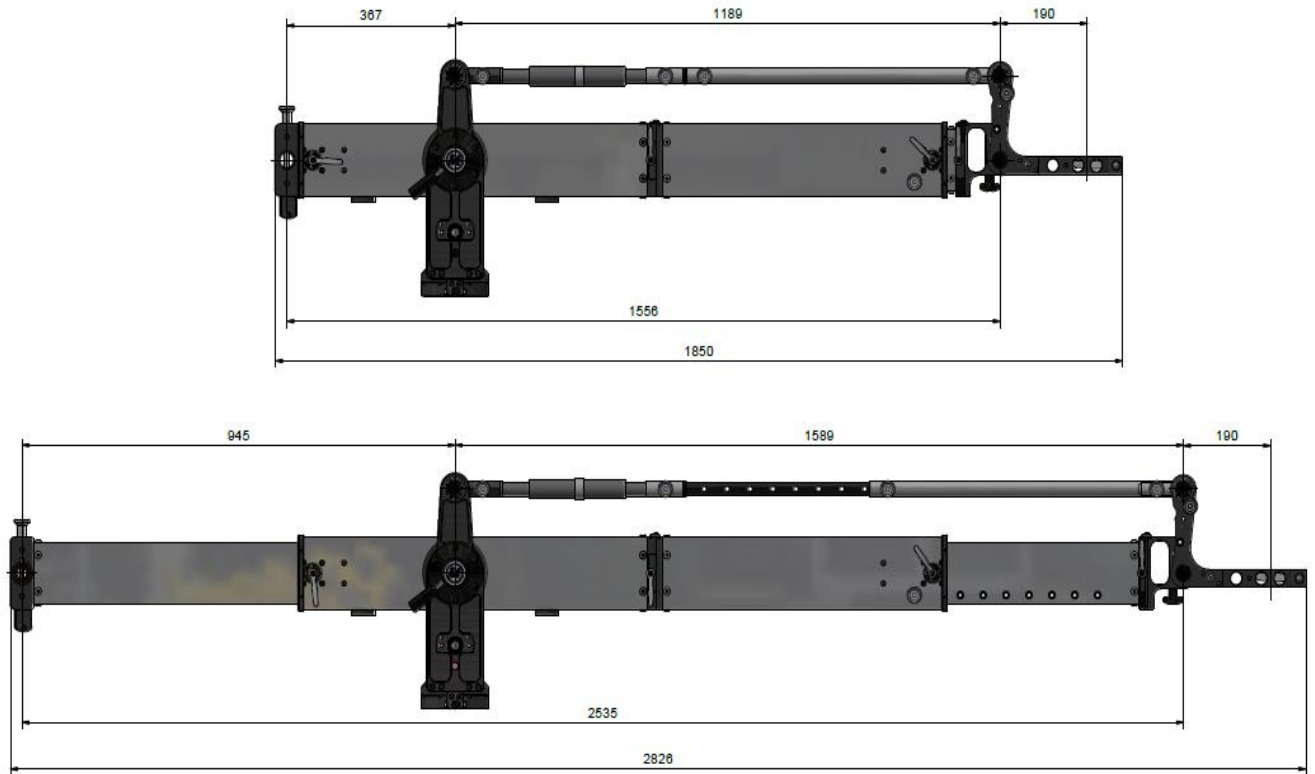

**Package includes:**

- 1 x Main Segment with crankable rear piece
- 1 x Extendable front segment
- 1 x Euro-mount head piece
- 1 x Hand crank
- 2 x Counterweight bars (long/short)

**Technical Data**

<b>GIZMO Jib – M</b>		
<b>Weight</b>	30 kg (66 lbs)	
	Retracted	Extracted
<b>Max. payload</b>	80 kg (176 lbs)	70kg (154 lbs)
<b>Counterweight required.</b>	120kg (265 lbs)	152 kg (335 lbs)

### 3) GIZMO Jib – Version L

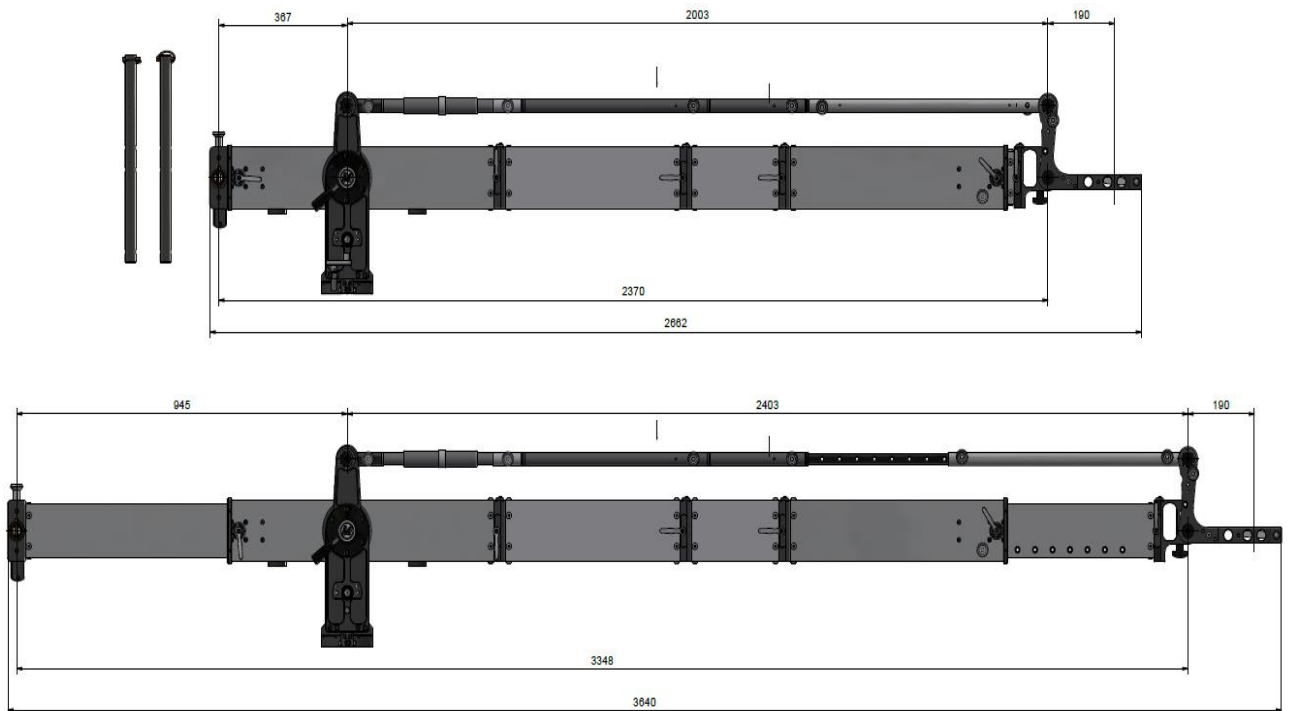

**Package includes:**

- 1 x Main Segment with crankable rear piece
- 1 x Extendable front segment
- 1 x Extension segment 0,25m
- 1 x Extension segment 0,5m
- 1 x Euro-mount head piece
- 1 x Hand crank
- 2 x Counterweight bars (long/short)

**Technical Data**

<b>GIZMO Jib – L</b>		
<b>Weight</b>	40 kg (88 lbs)	
	Retracted	Extracted
<b>Max. payload</b>	60kg (132 lbs)	50 kg (110 lbs)
<b>Counterweight required.</b>	184kg (406 lbs)	188kg (415 lbs)

#### 4) GIZMO Jib – Version XL

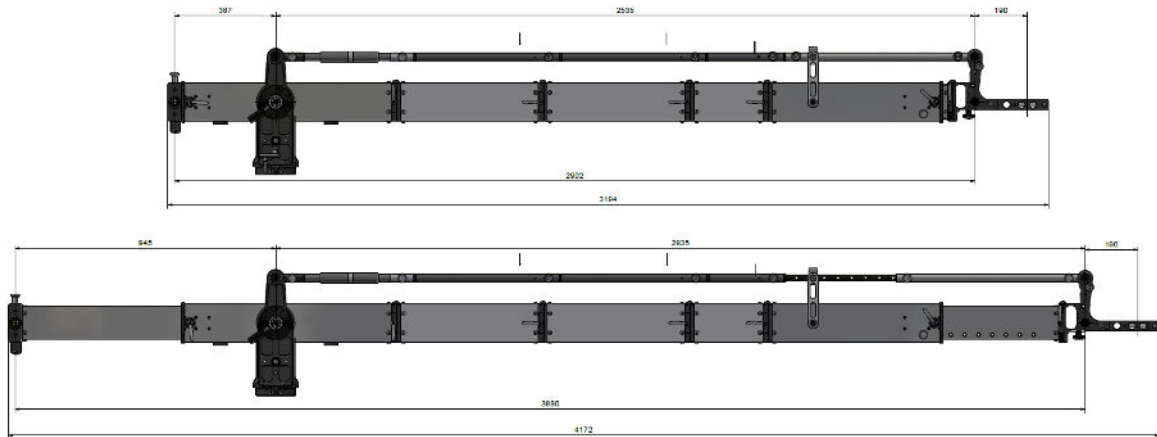

#### **Package includes:**

- 1 x Main Segment with crankable rear piece
- 1 x Extendable front segment
- 1 x Extension segment 0,25m
- 2 x Extension segment 0,5m
- 1 x Euro-mount head piece
- 1 x Hand crank
- 2 x Counterweight bars (long/short)

Length	Retracted	Extracted
<b>XL</b>	2505 mm	2905 mm

<b>GIZMO Jib – XL</b>		
<b>Weight</b>	44,5 kg (98 lbs)	
	Retracted	Extracted
<b>Max. payload</b>	45kg (99 lbs)	40kg (80 lbs)
<b>Counterweight required.</b>	192kg (423 lbs)	200kg (441 lbs)

## 5) GIZMO Jib – Version XXL

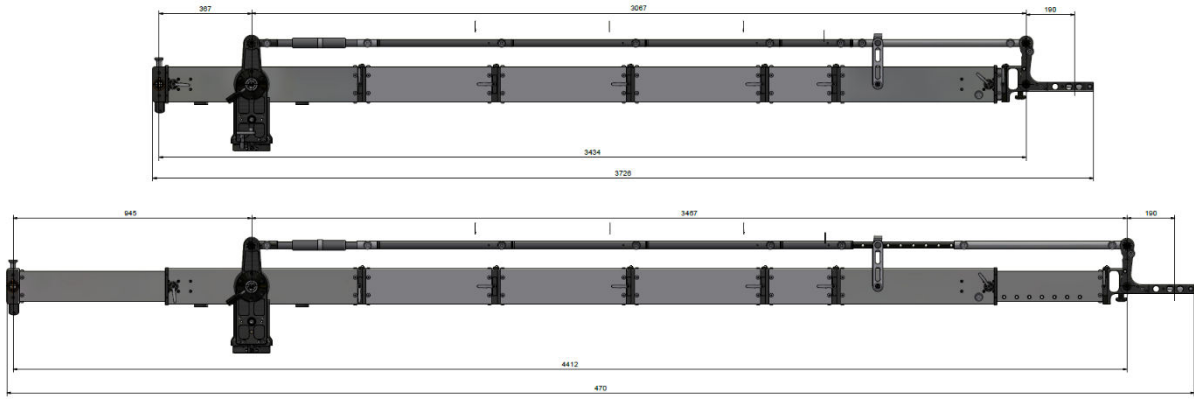

### **Package includes:**

- 1 x Main Segment with crankable rear piece
- 1 x Extendable front segment
- 1 x Extension segment 0,25m
- 3 x Extension segment 0,5m
- 1 x Euro-mount head piece
- 1 x Hand crank
- 2 x Counterweight bars (long/short)

Length	Retracted	Extracted
XXL	3005 mm	3405 mm

GIZMO Jib – XXL		
Weight	49kg(108 lbs)	
	Retracted	Extracted
Max. payload	35kg(77 lbs)	30kg(66 lbs)
Counterweight required.	204kg (450 lbs)	200kg (441 lbs)

## 7. Recurrent inspection

Ref. safety-related and und maschine-related equipment on stages and in studios.  
Certification of recurrent inspection according to „§34 UVV Veranstaltungs- und Produktionsstätten für szenische Darstellung (VBG 70).“

<b>Product:</b>	<b>MovieTech – GIZMO Jib</b>	
<b>The following inspections have been performed:</b>		
Date:	Description of maintenance:	Name:
Date:	Description of maintenance:	Name:
Date:	Description of maintenance:	Name:
Date:	Description of maintenance:	Name:
Date:	Description of maintenance:	Name:



**Test Sheet Movie Tech AG**

Confirmation of expertise for installation, inspection and maintenance of specific camera Jibs in accordance with BetrSichV and DGUV regulation 17. The expert inspection must be repeated annually from year 1 - 3. An expert inspection is required in year 4.

Examiners: .....

Date: .....

Manufacturer/ Type: .....

Serial number: .....

Customer name/ Owner: .....

	Tested	Defects		Others
		Yes	No	
<b>Visual inspection</b>				
Mechanical connections				
Deformation of parts, in particular segments				
Damage to parts, especially segments (dents/cracks)				
Thread of segments				
Rope and crimp connections				
Turnbuckles and hooks				
Axles				
Jib head with clamp/strap				
Jib centre part with threaded pin and brakes				
Counterweight unit with weight bars				
Struts/ Outrigger				
Completeness of all parts				

<b>Structure and functional test</b>				
Plug connection and segments				
Folding function Outrigger				
Screw connections Segments				
Swivel bearing / Smoothness / Noises				
Brakes (horizontal and vertical)				
Clamping Jib head 80mm/ Mitchell				

<b>Function test with payload</b>				
Max. Payload max. counterweight with function test				

<b>Comments:</b>



**Test Sheet Movie Tech AG**

Confirmation of expertise for installation, inspection and maintenance of specific camera Jibs in accordance with BetrSichV and DGUV regulation 17. The expert inspection must be repeated annually from year 1 - 3. An expert inspection is required in year 4.

Examiners: .....

Date: .....

Manufacturer/ Type: .....

Serial number: .....

Customer name/ Owner: .....

	Tested	Defects		Others
		Yes	No	
<b>Visual inspection</b>				
Mechanical connections				
Deformation of parts, in particular segments				
Damage to parts, especially segments (dents/cracks)				
Thread of segments				
Rope and crimp connections				
Turnbuckles and hooks				
Axles				
Jib head with clamp/strap				
Jib centre part with threaded pin and brakes				
Counterweight unit with weight bars				
Struts/ Outrigger				
Completeness of all parts				

<b>Structure and functional test</b>				
Plug connection and segments				
Folding function Outrigger				
Screw connections Segments				
Swivel bearing / Smoothness / Noises				
Brakes (horizontal and vertical)				
Clamping Jib head 80mm/ Mitchell				

<b>Function test with payload</b>				
Max. Payload max. counterweight with function test				

<b>Comments:</b>





**Test Sheet Movie Tech AG**

Confirmation of expertise for installation, inspection and maintenance of specific camera Jibs in accordance with BetrSichV and DGUV regulation 17. The expert inspection must be repeated annually from year 1 - 3. An expert inspection is required in year 4.

Examiners: .....

Date: .....

Manufacturer/ Type: .....

Serial number: .....

Customer name/ Owner: .....

	Tested	Defects		Others
		Yes	No	
<b>Visual inspection</b>				
Mechanical connections				
Deformation of parts, in particular segments				
Damage to parts, especially segments (dents/cracks)				
Thread of segments				
Rope and crimp connections				
Turnbuckles and hooks				
Axles				
Jib head with clamp/strap				
Jib centre part with threaded pin and brakes				
Counterweight unit with weight bars				
Struts/ Outrigger				
Completeness of all parts				

<b>Structure and functional test</b>				
Plug connection and segments				
Folding function Outrigger				
Screw connections Segments				
Swivel bearing / Smoothness / Noises				
Brakes (horizontal and vertical)				
Clamping Jib head 80mm/ Mitchell				

<b>Function test with payload</b>				
Max. Payload max. counterweight with function test				

<b>Comments:</b>



**Test Sheet Movie Tech AG**

Confirmation of expertise for installation, inspection and maintenance of specific camera Jibs in accordance with BetrSichV and DGUV regulation 17. The expert inspection must be repeated annually from year 1 - 3. An expert inspection is required in year 4.

Examiners: .....

Date: .....

Manufacturer/ Type: .....

Serial number: .....

Customer name/ Owner: .....

	Tested	Defects		Others
		Yes	No	
<b>Visual inspection</b>				
Mechanical connections				
Deformation of parts, in particular segments				
Damage to parts, especially segments (dents/cracks)				
Thread of segments				
Rope and crimp connections				
Turnbuckles and hooks				
Axles				
Jib head with clamp/strap				
Jib centre part with threaded pin and brakes				
Counterweight unit with weight bars				
Struts/ Outtrigger				
Completeness of all parts				

<b>Structure and functional test</b>				
Plug connection and segments				
Folding function Outtrigger				
Screw connections Segments				
Swivel bearing / Smoothness / Noises				
Brakes (horizontal and vertical)				
Clamping Jib head 80mm/ Mitchell				

<b>Function test with payload</b>				
Max. Payload max. counterweight with function test				

<b>Comments:</b>



**Test Sheet Movie Tech AG**

Confirmation of expertise for installation, inspection and maintenance of specific camera Jibs in accordance with BetrSichV and DGUV regulation 17. The expert inspection must be repeated annually from year 1 - 3. An expert inspection is required in year 4.

Examiners: .....

Date: .....

Manufacturer/ Type: .....

Serial number: .....

Customer name/ Owner: .....

	Tested	Defects		Others
		Yes	No	
<b>Visual inspection</b>				
Mechanical connections				
Deformation of parts, in particular segments				
Damage to parts, especially segments (dents/cracks)				
Thread of segments				
Rope and crimp connections				
Turnbuckles and hooks				
Axles				
Jib head with clamp/strap				
Jib centre part with threaded pin and brakes				
Counterweight unit with weight bars				
Struts/ Outtrigger				
Completeness of all parts				

<b>Structure and functional test</b>				
Plug connection and segments				
Folding function Outtrigger				
Screw connections Segments				
Swivel bearing / Smoothness / Noises				
Brakes (horizontal and vertical)				
Clamping Jib head 80mm/ Mitchell				

<b>Function test with payload</b>				
Max. Payload max. counterweight with function test				

<b>Comments:</b>



## The MovieTech family

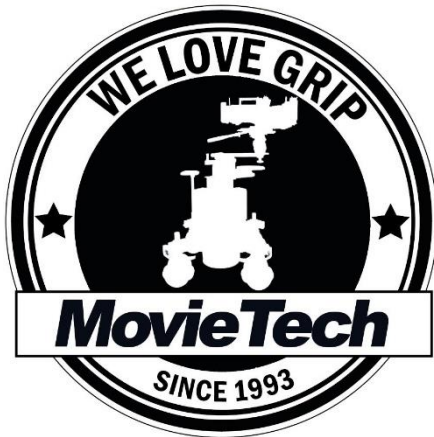

Everyone at MovieTech is passionate about grip equipment.

Our brand stands for high quality and reliable grip equipment – since 1993.

In order to meet the high demands of our customers and to fulfill our motto

**“Grip-Equipment you can rely on”**, we produce all our MovieTech products with passion and care in our factory in Munich.

Always with the aim of developing user-friendly, versatile, robust and reliable camera support systems that users will love.

## MovieTech

## ABC PRODUCTS

by MovieTech

## MTS

Media Technical System  
by MovieTech

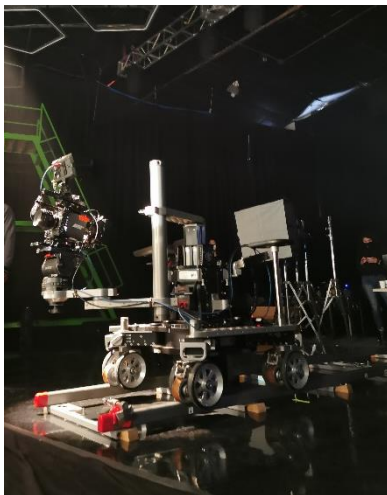

[www.movietech.de](http://www.movietech.de)



[www.abc-products.de](http://www.abc-products.de)

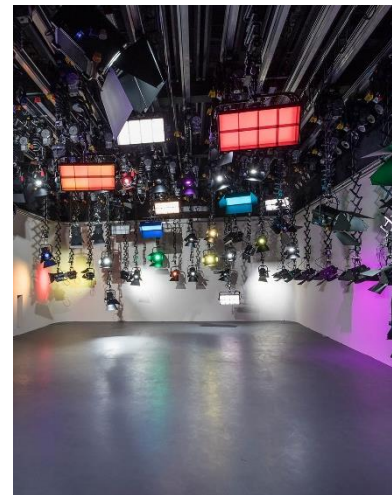

[www.mts-germany.de](http://www.mts-germany.de)

**MovieTech AG**  
Martin-Kollar-Str. 9  
80801 Munich – Germany  
+49 (0) 89 /436 891 3 | [info@movietech.de](mailto:info@movietech.de)